



ISSN (Print) : 2320 – 3765  
ISSN (Online): 2278 – 8875

## International Journal of Advanced Research in Electrical, Electronics and Instrumentation Engineering

(A High Impact Factor, Monthly, Peer Reviewed Journal)

Website: [www.ijareeie.com](http://www.ijareeie.com)

Vol. 6, Issue 10, October 2017

# Designing of Circular Monopole Patch Antenna Loaded with Split Ring Resonator

Apoorva D\*

Department of Electronics & Communication Engineering, Meerut Institute of Engineering & Technology,  
Meerut, India

**ABSTRACT:** The EM conduct of the coplanar waveguide fed, filled split ring resonator to the ultra-wideband antenna with single band notch symptoms have offered. The proposed size of antenna  $30 \times 35 \times 1.6 \text{ mm}^3$  is very compact and easy to integrate with handheld devices. Here the antenna loaded with SRRs to create single frequency notch in 6.41GHz to 8.26 GHz used for X-band satellite communication. The radiation pattern of H-plane is omnidirectional and radiation pattern of E-plane exhibits like a dipole. The antenna gain is stable across the absolute operating frequency besides at notch. Therefore, a VSWR  $< 2$  with a large bandwidth was clearly identifiable. This work investigates several problems simulated using High frequency structure simulator tool.

**KEYWORDS:** Ultrawideband; Circular monopole; Splitring resonator; Coplanar waveguide; Circular monopole antenna; Effective isotropic radiated power

## I. INTRODUCTION

In 2002, the FCC (Federal Communications Commission) release of 10 dB unlicensed bandwidth of 7.5 GHz, ranging from 3.1 to 10.6 GHz by effective isotropic radiated power (EIRP) spectral density as  $-41.3 \text{ dBm/MHz}$  for commercial use in radio communication. The UWB (Ultra Wideband) communication has witnessed all over the world to make use of this bandwidth for enhanced data rate and a variety of other purposes. The UWB communication has the inherent advantage of low power consumption, simple structure, small size and ease of concord together with high transmission rates and relatively good omnidirectional property. While 7.5 GHz bandwidth is the core motivation for developing high data rate devices, which may potentially meddle with UWB communication such as X-band satellite communication system at 8.23GHz. While having wave frequency from 6.19GHz to 8.03 GHz for downlink and 8.03GHz to 8.57 GHz for uplink communication. The antenna being an essential component of UWB communication, it is thus incumbent to design the same having band notched function to avoid interference with the excluding wireless network technologies. The main challenge in designing an UWB antenna for indoor communication system is the avoidance of interference with egress narrowband services, which may cause potential interference.

Characteristic of the multi-frequency signal rejection, complementary co-directional SRR is promising for UWB antenna ensure multiple notched bands. With its help in this communication, single, dual, triple notched bands can be clearly identifiable at such a dense antenna respectively. In the recent literature, the UWB monopole planar antenna is widely used due to its simple structure and low cost. Several designs of monopole planar UWB antenna have proposed. Some of these antennas, it involves complex calculation and complicated fabrication process. Therefore, we use a simple method to design the Coplanar Waveguide (CPW) feed circular monopole antenna using UWB applications with notch characteristics [1-4].



# International Journal of Advanced Research in Electrical, Electronics and Instrumentation Engineering

(A High Impact Factor, Monthly, Peer Reviewed Journal)

Website: [www.ijareeie.com](http://www.ijareeie.com)

Vol. 6, Issue 10, October 2017

## II. PROPOSED ANTENNA DESIGN

A Coplanar Waveguide feed circular monopole antenna with return loss graph, which shows below -10dB for entire UWB bandwidth 3.1GHz to 10.6 GHz in Figure 1.

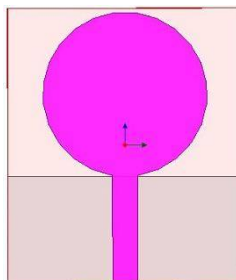

Figure 1: Circular monopole antenna CMA.

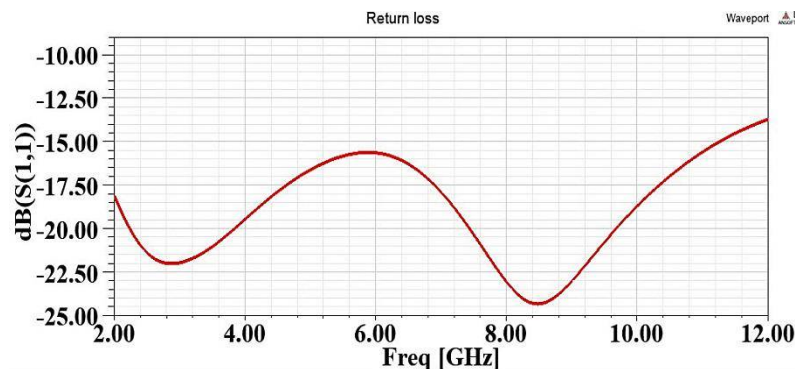

Figure 2: Simulated graph of CMA.

For further betterment, we used SRR (Split Ring Resonator) in this antenna design. This paper describes a design of single band UWB circular monopole antenna loaded by SRR on the opposite surface of a CPW fed circular monopole antenna. The SRR pair is inductively coupled to the radiator and loaded on the side-by-side of the CPW feed line, which results in a notch frequency determined by the SRR geometrical dimensions. SRR is one of the metamaterials artificial structures that are implemented in antenna design for their unique negative permittivity/permeability properties. SRR will be designed using the material to achieve notch characteristics centered at 4.3 GHz so as to reduce the interference from X-band satellite communication system. The suppression of the useless radiation from the X- band Satellite Communication, notch frequency is due to the effect of a strong magnetic coupling between the SRR. The magnetic coupling between the SRRs is used here to filter out the undesired frequencies and avoid possible interference within the UWB (3.1 to 10.6 GHz) region [5,6] (Figure 2).

# International Journal of Advanced Research in Electrical, Electronics and Instrumentation Engineering

(A High Impact Factor, Monthly, Peer Reviewed Journal)

Website: [www.ijareeie.com](http://www.ijareeie.com)

Vol. 6, Issue 10, October 2017

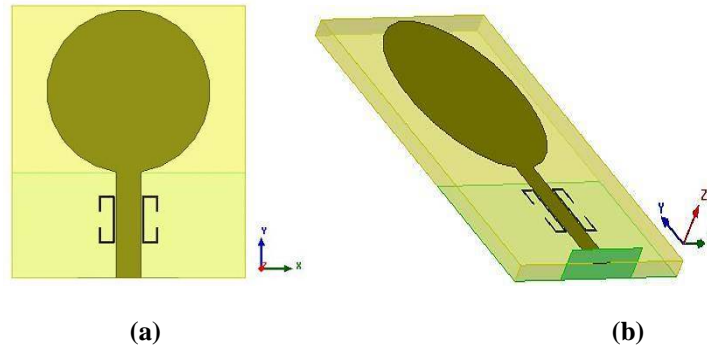

**Figure 3: Design of proposed antenna (a) top view and (b) side view of antenna.**

The proposed antenna has optimized by using HFSS (High Frequency Structure Simulator). The rectangular shaped SRR is placed on the side by side of the CPW feed line with a 0.2 mm small difference should be properly arranged in such a manner so that antenna is able to operate on 4.3 GHz. Antenna design is shown in Figure 3. In Figure 3a shows a top view of the antenna and Figure 3b shows the side view of antenna and side view showing substrate, patch, and ground and feeding of designing an antenna.

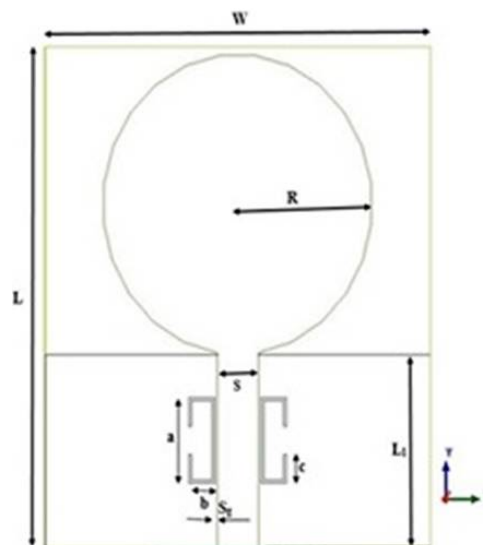

**Figure 4: Parameter of an antenna design.**

Parametric view of designing antenna is shown in Figure 4. The dimension of each part of circular monopole antenna SRR, ground and the patch are shown above. Length and width of the antenna and each part are shown by using parameters L, W, R, S, S<sub>g</sub>, L<sub>1</sub>, a, b and c. In this FR4 material substrate is used. The length and width of CPW feed line are also independent and could be changed according to the desired results. In this design, the length of feed is 3 mm, the width of the feed is 13 mm and that feed connects with the ground and a patch of the antenna (Table 1).



# International Journal of Advanced Research in Electrical, Electronics and Instrumentation Engineering

(A High Impact Factor, Monthly, Peer Reviewed Journal)

Website: [www.ijareeie.com](http://www.ijareeie.com)

Vol. 6, Issue 10, October 2017

Parameter	Value(mm)
L	35
W	30
R	10.46
L <sub>1</sub>	13.5
S	3.2
S <sub>g</sub>	0.2
A	6
B	2
C	2

**Table 1: Parameters L, W, R, S, S<sub>g</sub>, L<sub>1</sub>, A, B and C.**

The propagating EM signal along the CPW feed line having its magnetic field oriented along the axis. The SRR induces an electromotive force which turninduces a current oscillating between the two rings of the SRR. This oscillating current between two rings yields a resonance, which determined by the SRR's geometry and prohibits signal propagation at that frequency. This resonance frequency can be determined from the equivalent current approach demonstrated in which involves calculation of distributed capacitance between the rings of the SRR and total inductance of the SRR.The SRR resonance frequency can calculate from the following section. SRR resonance frequency calculated by formulae,

$$f_0 = 1 / 2\pi / \sqrt{LC} \quad (1)$$

The notch characteristics of the SRR loaded CPW feed circular monopole antenna can be calculate using the following formulae:

$$\epsilon_{eff} f = (\epsilon_r + 1) / 2 + (\epsilon_r - 1) / 2(1 + 12(\frac{H}{w}))^{-1/2} \quad (2)$$

Where,  $\epsilon_{eff}$  is the effective dielectric constant and  $\epsilon_r$  is 4.4 as the substrate is FR4, h is 1.6 mm having height of the substrate. By using, all values  $\epsilon_{eff}$  can be calculate.

### III. SIMULATED RESULTS AND DISCUSSION

ACPW fed circular monopole UWB antenna to obtain single frequency notch is simulated on FR4 substrate having thickness h=1.6 mm and dielectric constant  $\epsilon_r=4.4$ . This prototypewas designed and simulated on FR4 material using a commercial EM simulator that is HFSS.

UWB antenna operates in the frequency range 3.1 to 10.6GHz.The S11of the CMA shows in Figure 2 should be less than -10 dB to get the stable radiation characteristics throughout entire bandwidth In Figure 5 shows the frequency response of the circular monopole antenna with dip of the notch characteristics below from -10dB for the entire bandwidth (3.1 GHz to 10.6GHz). The current oscillating between theSRR exhibits filter characteristics, which determined by SRR geometry and desired notch frequency. The rectangular shaped SRR is placed on the patch of the circular monopole antenna and arranged side-by-side of the CPW feed line and due to this notch generated [7].



# International Journal of Advanced Research in Electrical, Electronics and Instrumentation Engineering

(A High Impact Factor, Monthly, Peer Reviewed Journal)

Website: [www.ijareeie.com](http://www.ijareeie.com)

Vol. 6, Issue 10, October 2017

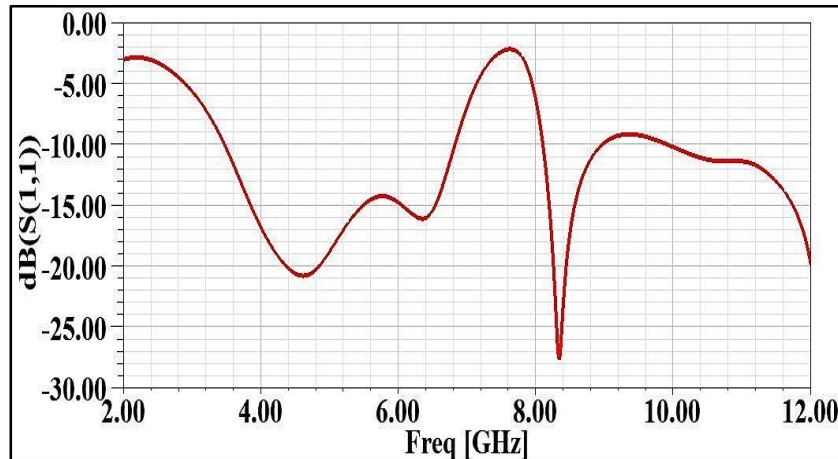

Figure 5: Simulated return loss ( $S_{11}$ ) of the SRR loaded CPW fed UWB circular monopole antenna with notch frequency.

The notch of X-band satellite communication is generated because of SRR has 8.23 GHz frequency notch and -28.83 dB (8.01 to 8.57 GHz) return loss. Moreover, the X-band satellite communication is reserve for armament services. This is the combined return loss graph with and without SRR loaded (Figures 6 and 7) (Table 2).

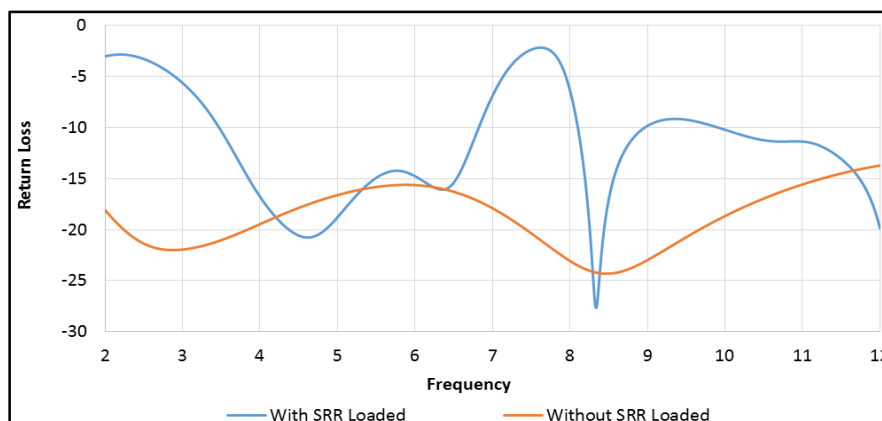

Figure 6: Simulated return loss with and without SRR loaded.



# International Journal of Advanced Research in Electrical, Electronics and Instrumentation Engineering

(A High Impact Factor, Monthly, Peer Reviewed Journal)

Website: [www.ijareeie.com](http://www.ijareeie.com)

Vol. 6, Issue 10, October 2017

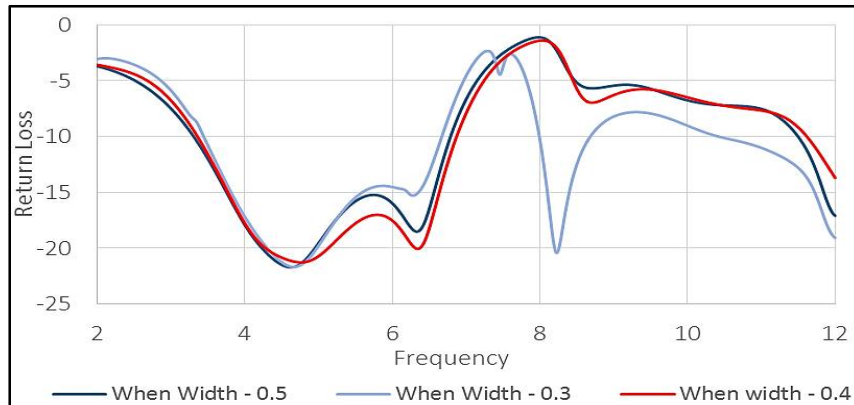

Figure 7: Simulated return loss with different SRR values.

Value	Return Loss
0.3	-22dB at 4.5 GHz
0.4	-21dB at 4.5GHz
0.5	-22dB at 4.3GHz

Table 2: Different values of SRR.

The VSWR plot of the SRR loaded circular monopole antenna is shown in Figure 8. The Figure 8 observed that VSWR values are less than 2 for entire bandwidth except 7.34 GHz notch frequency.

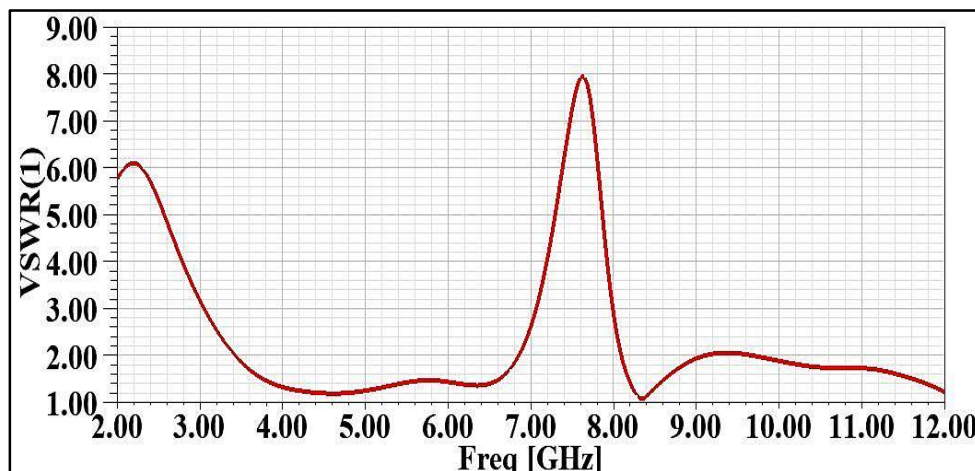

Figure 8: Simulated VSWR of the antenna.

For better rejection coefficient, the voltage standing wave ratio should be less than 2. This is the combined VSWR graph with and without SRR loaded shows in Figure 9.



# International Journal of Advanced Research in Electrical, Electronics and Instrumentation Engineering

(A High Impact Factor, Monthly, Peer Reviewed Journal)

Website: [www.ijareeie.com](http://www.ijareeie.com)

Vol. 6, Issue 10, October 2017

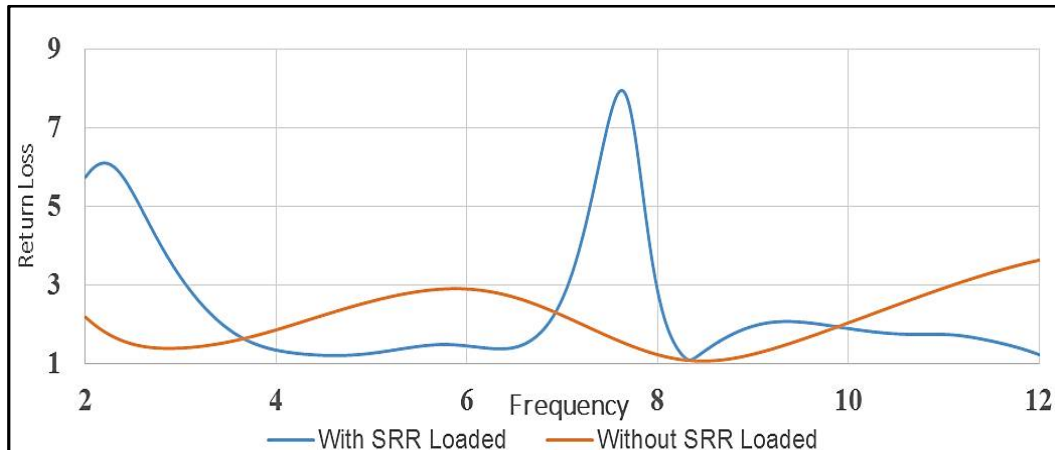

Figure 9: Simulated VSWR with and without SRR loaded.

#### IV. RADIATION PATTERN WITH SRR

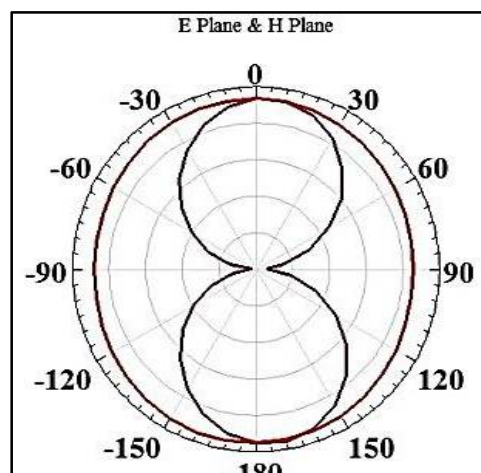

Figure 10: Radiation pattern of the E and H plane directional pattern.

The radiation pattern shows the variation of the power radiated by an antenna is a function of the direction away from the antenna. This power variation function in arrival angle has observed in the antenna's far field.





# International Journal of Advanced Research in Electrical, Electronics and Instrumentation Engineering

(A High Impact Factor, Monthly, Peer Reviewed Journal)

Website: [www.ijareeie.com](http://www.ijareeie.com)

Vol. 6, Issue 10, October 2017

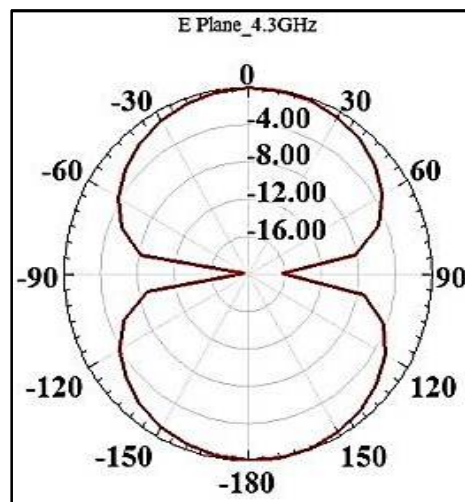

Figure 11: Radiation pattern of E-plane.

## V. RADIATION PATTERN OF WITHOUT SRR

The center frequency of desired antenna is 4.3GHz, the whole antenna will support on the center frequency at 4.3GHz, and the bandwidth is 3.1 GHz to 10.6 GHz (Ultra-wideband frequency). The Radiation pattern of the proposed antenna for 4.3GHz is shown in Figure 10. The antenna design shows a directional radiation pattern, in other words, an antenna radiate in a particular direction and operate its own center frequency at 4.3GHz. The Radiation pattern of the proposed antenna for omnidirectional pattern and directional pattern is shown in Figure 11. Radiation pattern for omnidirectional at  $(\Phi = 0^\circ)$   $\phi = 0^\circ$  and directional pattern at  $(\Phi = 90^\circ)$   $\phi = 90^\circ$ . Omnidirectional pattern has plotted on an XZ - Plane and the directional pattern has plotted on a YZ - plane. In Figure 10, the radiation pattern of directional antenna is also known Dipole pattern (E - Plane) and the omnidirectional pattern is on H-Plane. In Figure 11, the radiation patterns are on the EH - plane [8-12].

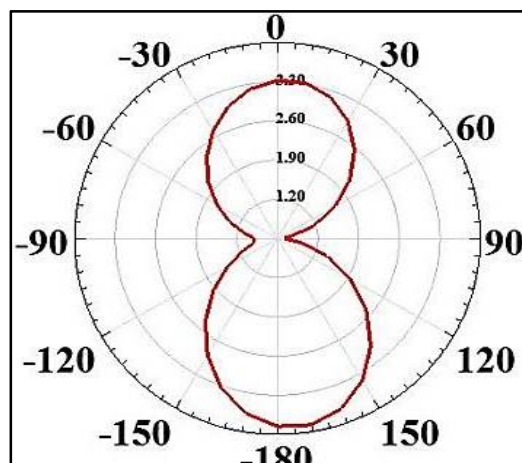

Figure 12: Radiation pattern of E-plane without SRR loaded.



# International Journal of Advanced Research in Electrical, Electronics and Instrumentation Engineering

(A High Impact Factor, Monthly, Peer Reviewed Journal)

Website: [www.ijareeie.com](http://www.ijareeie.com)

Vol. 6, Issue 10, October 2017

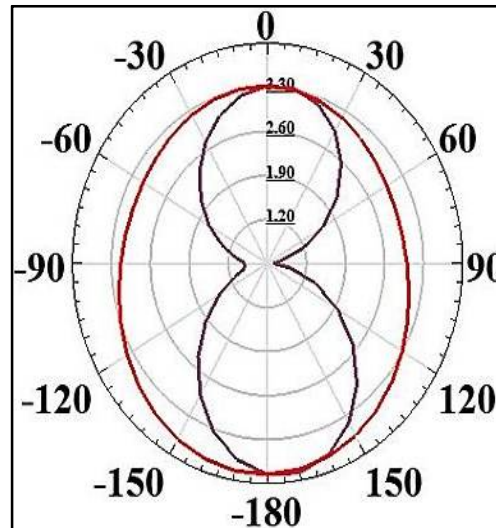

Figure 13: Radiation pattern of E & H plane without SRR loaded.

## VI. CURRENT DISTRIBUTION WITH SRR

Current distribution with srr can be further investigated in terms of leaky-wave interaction between the ground plane and the feed line and the radiating patch. The leaky wave was presented through the leakage current distribution as shown in Figures 12-15. It can be seen that the leakage current distribution from the ground plane is weaker. As a result, the operational characteristics of the antenna become better [13].

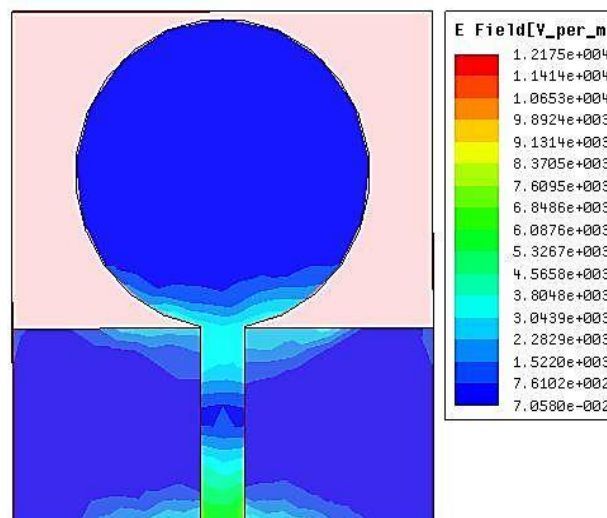

Figure 14: Current distribution without SRR loaded.



# International Journal of Advanced Research in Electrical, Electronics and Instrumentation Engineering

(A High Impact Factor, Monthly, Peer Reviewed Journal)

Website: [www.ijareeie.com](http://www.ijareeie.com)

Vol. 6, Issue 10, October 2017

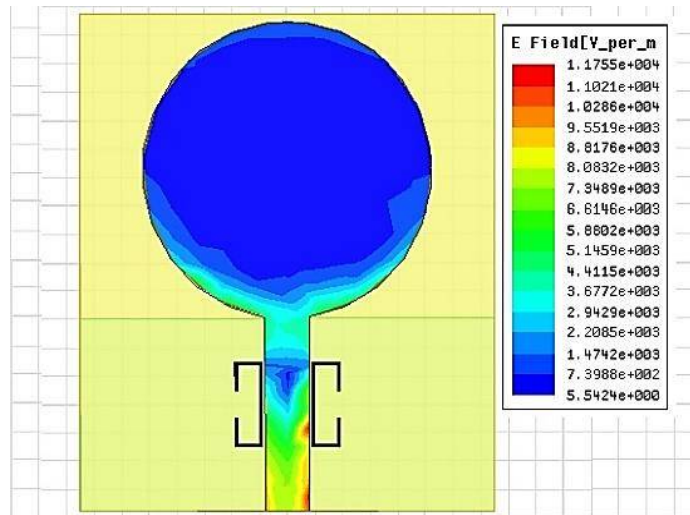

Figure 15: Current distribution with SRR.

## VII. CONCLUSION

A CPW fed circular monopole UWB antenna loaded with rectangular shaped SRRs with single frequency notch characteristics on FR4 substrate has been proposed and presented in this work. The work with precise positioning of the SRR place on the side-by-side of the CPW feed line. The proposed antenna is able to cover the entire UWB spectrum except at 8.23GHz which obtained by SRR. The electromagnetic coupling between the CPW and SRR at its resonance frequency yields the desired frequency notch. Since, the antenna dimension and SRR dimensions are independent of each other, SRR dimension only depends on the notching frequency. The notch frequency can be customized to the desired value by changing the SRR dimensions.

## REFERENCES

- [1] Siddiqui JY; Saha C; Antar YMM; Compact SRR Loaded UWB Circular Monopole Antenna with Frequency Notch Characteristics. IEEE transactions on antennas and propagation 2014; 62:4015-4020.
- [2] Wang P; Wen GJ; Huang YJ; Sun YH; Compact CPW-fed planar monopole antenna with distinct triple bands for Wi-Fi/WiMAX applications. Electron Lett 2012; 48: 357–359.
- [3] Nguyen DT; Lee DH; Park HC; Very compact printed triple band-notched UWB antenna with quarter-wavelength slots. IEEE Antennas Wireless Propag Lett 2012; 11: 411–414.
- [4] Tang MC; Xiao S; Deng T; Wang D; Guan J, et al. Compact UWB antenna with multiple band-notches for WiMAX and WLAN. IEEE Trans Antennas Propag 2011; 59: 1372–1376.
- [5] Zhang LN, Zhong SS, Du CZ, Chen JN, Compact UWB planar monopole antenna with band-notch function Microw Opt Technol Lett 2009; 51: 1908–1911.
- [6] Peng L; Ruan CL; UWB band-notched monopole antenna design using electromagnetic-bandgap structures. IEEE Trans Microw Theory Tech 2011; 59: 1074–1081.
- [7] Liu WC; Dual wideband coplanar waveguide-fed notched antennas with asymmetrical grounds for multi-band wireless application. IET Microw Antennas Propag 2007; 5: 980–985.
- [8] Liang J; Guo L; Chiau CC; Chen X; Parini CG; Study of CPW-fed circular disc monopole antenna for ultra-wideband applications. IEEE Proc Microw Antennas Propag 2005; 52: 520–526.
- [9] Liu HW, Ku CH; Yang CF; Novel CPW-fed planar monopole antenna for WiMAX/WLAN applications,” IEEE Antennas Wireless Propag. Lett 2010; 9: 240–243.
- [10] Jawad KA, A new dual band E shaped slot antenna design for wireless applications. Progress in Electromagnetic Research Symposium Proceedings 2011; 12-16: 1258-1261.



ISSN (Print) : 2320 – 3765  
ISSN (Online): 2278 – 8875

# International Journal of Advanced Research in Electrical, Electronics and Instrumentation Engineering

*(A High Impact Factor, Monthly, Peer Reviewed Journal)*

Website: [www.ijareeie.com](http://www.ijareeie.com)

**Vol. 6, Issue 10, October 2017**

- [11]Gao GPL; Mei ZL; Li BN; Novel circular slot UWB antenna with dual band-notched characteristic. Progress in Electromagnetic Research C 2010; 15: 49-63.
- [12]Kim KH, Park SO, Design of the band-rejected UWB antenna with the ring-shaped parasitic patch. Microwave and Optical Technology Letters 2006; 48: 1310–1313.
- [13]Hong CY, Ling CW, Tarn IY, Chung SJ, Design of a planar ultra-wide band antenna with a new band-notch structure. IEEE Trans Antennas Propag 2007; 55: 3391-3397.